

PUMP PERFORMANCE CURVES

TYPE: SUBMERSIBLE DRAINAGE PUMP

MODEL: 200MH37

FREQUENCY: 50Hz

STANDARD SPECIFICATIONS

DISCHARGE BORE

200 mm

HEAD

Max: 48 m

Rated: 35 m

CAPACITY

Max: 5.5 m³/min

Rated: 3.6 m³/min

MOTOR OUTPUT

37 kW

PHASE x VOLTAGE

3 Øx 380/400V

CURRENT

66 A

POLES/REVOLUTION

2 P/ S.S.2850 min⁻¹

STARTING METHOD

Star-Delta start

INSULATION CLASS

F/H

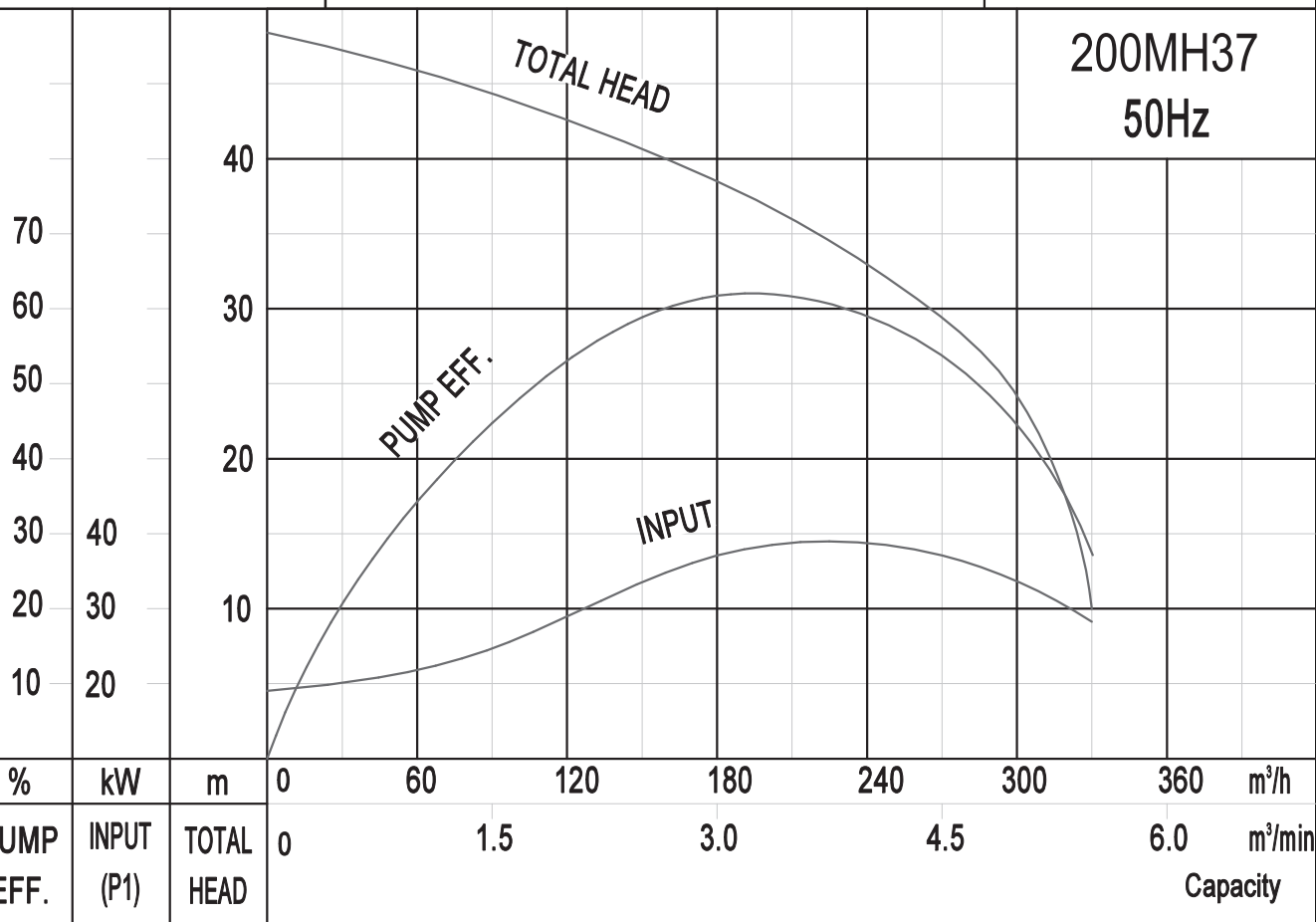

SOLIDPUMP EUROPE SIA

DIMENSION DRAWING
TYPE: **SUBMERSIBLE DRAINAGE PUMP**

MODEL: 200MH37

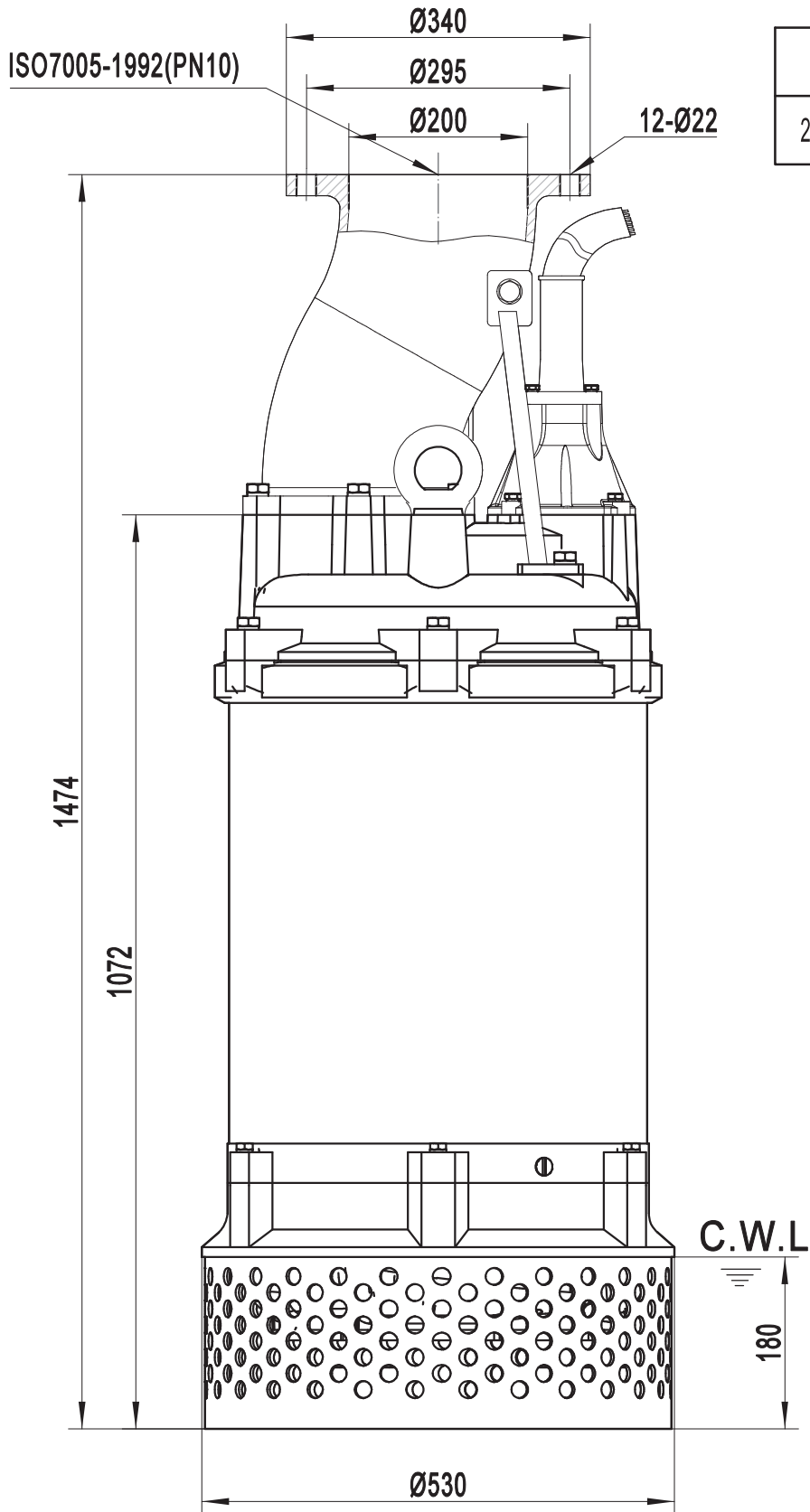

Model	N.W(kg)
200MH37	575

C.W.L.:Continuous Running Water Level.

SOLIDPUMP EUROPE SIA

DIMENSION DRAWING

TYPE: SUBMERSIBLE DRAINAGE PUMP

MODEL: 200MH37

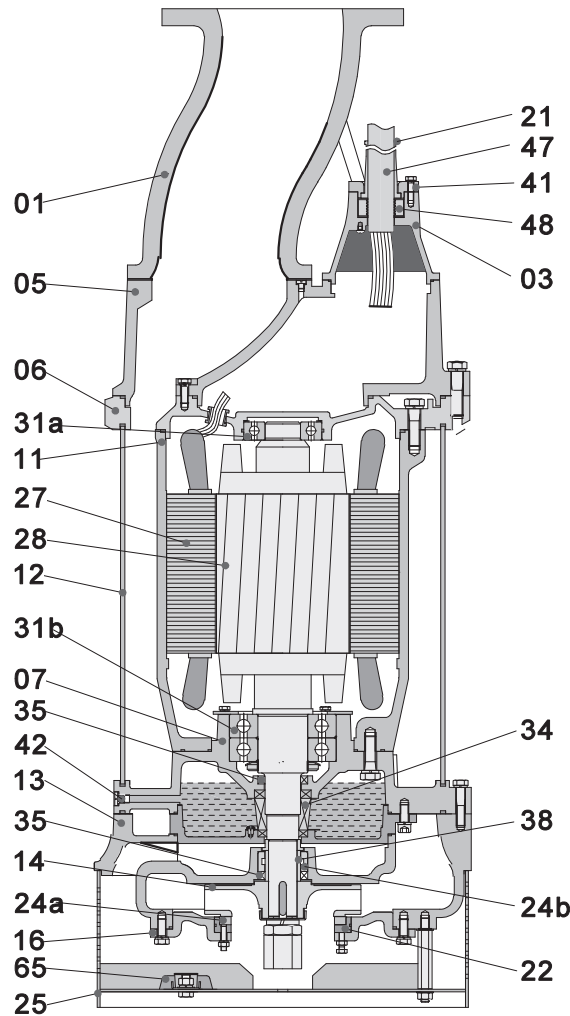

Item No.	Part name	Material	Item No.	Part name	Material
01	Hose coupling	Ductile iron	25	Strainer	AISI304SS
03	Terminal box	Cast iron	27	Stator	
05	Upper cover	Cast iron	28	Rotor	Shaft:AISI420SS
06	Up-Bearing house	Cast iron	31a	Bearing	Ball bearing
07	Bearing house	Cast iron	31b	Bearing	Ball bearing
11	Motor body	Cast iron	34	Mechanical seal	Tc-Sic/Sic-Sic
12	Outer casing	Steel	35	Oil seal	
13	Pump body	Cast iron	38	Shaft sleeve	AISI304SS
14	Impeller	High chrome alloy	41	Cable fixing plate	Cast iron
16	Inlet plate	Cast iron	42	Screw	H62
21	Cable tube	NBR	47	Cable	
22	Seat assembly	Cast iron	48	Cable bead	NBR
24a	Neck ring	High chrome alloy	65	Cathodic protection plate	AL
24b	Neck ring	AISI304SS			

Specifications can be changed without notice

Solidpump Europe SIA

Uriekstes iela 14a
Rīga, LV-1005
LATVIA

Tel.: + 371 66968996
E-mail: info@solidpump.com
www.solidpump.com

Ver. 21.11.2022

SOLIDPUMP EUROPE SIA